

广州智光储能科技有限公司

GUANGZHOU ZHIGUANG ENERGY STORAGE TECHNOLOGY CO., LTD.

2022版（英文）

Company Introduction V2.1

CONTENTS

- 01** | **Company Profile**
- 02** | **Core Technology and Products**
- 03** | **Typical Applications**

01

Company Profile



1、Company Profile

- 📍 The company is based in Guangzhou and was established in February 2018, is a holding subsidiary of Guangzhou Zhiguang Electric Co., Ltd. [stock code: 002169] and is registered with 140.2 million Yuan.
- 📍 National High Technology Enterprise, Guangdong Provincial Science and Technology Medium-Sized Enterprise, Guangzhou "Two High and Four New (specialized and special)" Enterprise, Guangzhou Green Enterprise, Guangzhou Seed-Unicorn Enterprise.
- 📍 The first batch of science and technology innovation (energy storage) demonstration project units.
- 📍 ISO9001、ISO14001、OHSAS Certification .

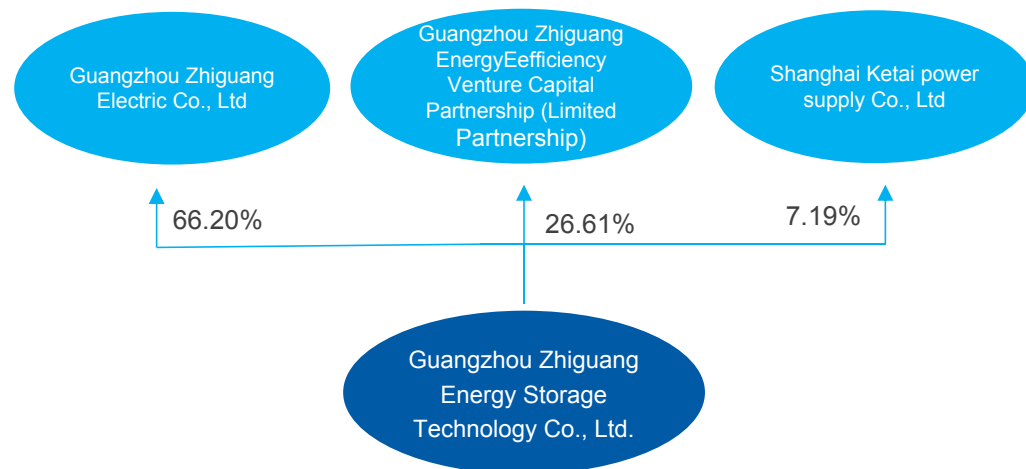

2、 Business Scope

- Guangzhou Zhiguang Energy Storage Technology Co., Ltd., established in 2018, is a holding subsidiary of Guangzhou Zhiguang Electric Co., Ltd. [hereinafter referred to as Zhiguang], and is an important layout of Zhiguang in the strategic development direction of digital energy technology and integrated energy services. The company makes full use of the parent company's more than 20 years of research and application experience in power electronics technology, automation, and information technology, and smart energy technology, actively introduces senior research teams in the battery industry, widely carries out domestic and international university cooperation, and builds a professional research team in the fields of the battery pack, BMS, EMS, and PCS.
- The company not only provides services including energy storage investment, energy storage system integration, energy storage equipment sales, etc., but also provides core key technologies and equipment such as energy storage battery PACK integration, BMS, PCS and EMS, and can provide battery cell and battery PACK testing technology services.
- The company's energy storage product lineup includes power station-type large-capacity energy storage systems (cascaded high-voltage energy storage), demand-side energy storage systems (modular low-voltage energy storage) and mobile energy storage products.



Committed to the research and application of industrial technology in the field of energy storage



Guangdong Province, Guangzhou renewable energy industry energy storage leading enterprises



The first international cascaded high-voltage energy storage system, is the National 863 research project, developed by the company which is the international-leading level, leading the development of safe and efficient large scale energy storage technology.



3、 Development strategy and technical route

Development Strategy

In the new situation of dual carbon, relying on independent research and development to master the core technology of energy storage system, Zhiguang will become a leading enterprise in the cascade technology route of energy storage and is committed to becoming an expert on exploring the value of the whole life cycle of the energy storage system.

With the support of the integrated development of technology and capital, the compound annual growth rate will be more than 70% during the 14th Five-Year Plan of China.

Technical Proposition

In the field of energy storage, Zhiguang firmly practices the research and promotion of the use of large-scale energy storage systems without no parallel connection on battery packs and clusters and is committed to improving the safety, cell consistency, and system efficiency of the energy storage system, achieving a breakthrough in the key technology of 25MW energy storage with one single unit and providing security with easy management, lower life cycle cost and efficient energy storage system for the construction of the new power systems.

4、 R&D System and Capability

- ◆ The core support unit of the postdoctoral workstation of the joint-stock company.
- ◆ The world's first cascaded direct high-voltage large-capacity energy storage technology, and identified as the international leading level.
- ◆ Guangdong Provincial Development and Reform Commission high-power power electronics engineering laboratory is the only listed unit.
- ◆ 10MW energy storage system stand-alone testing capability, 6~35kV large-capacity high-voltage laboratory, complete high-voltage power supply test conditions .
- ◆ The service and operation experience of high-power power electronic products in more than 30 countries around the world has more than 15,000 sets of high-power power electronic equipment with high temperature, low temperature, high altitude, high temperature difference, coastal and other climatic characteristics in more than 15,000 units of high-power power electronic equipment with voltage level of 6-35kV.

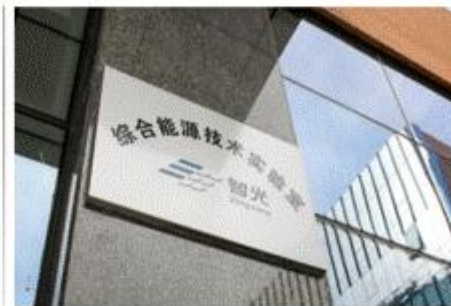
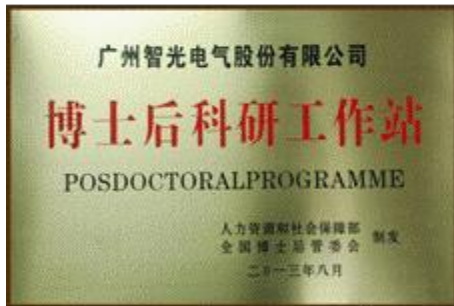

4、R&D System and Capability

With more than 20 years of research and accumulation of high-power power electronics technology, the company has successfully developed a variety platform of technologies and accumulated lots of experience in energy storage thermal management, power electronics topology, and battery system solutions

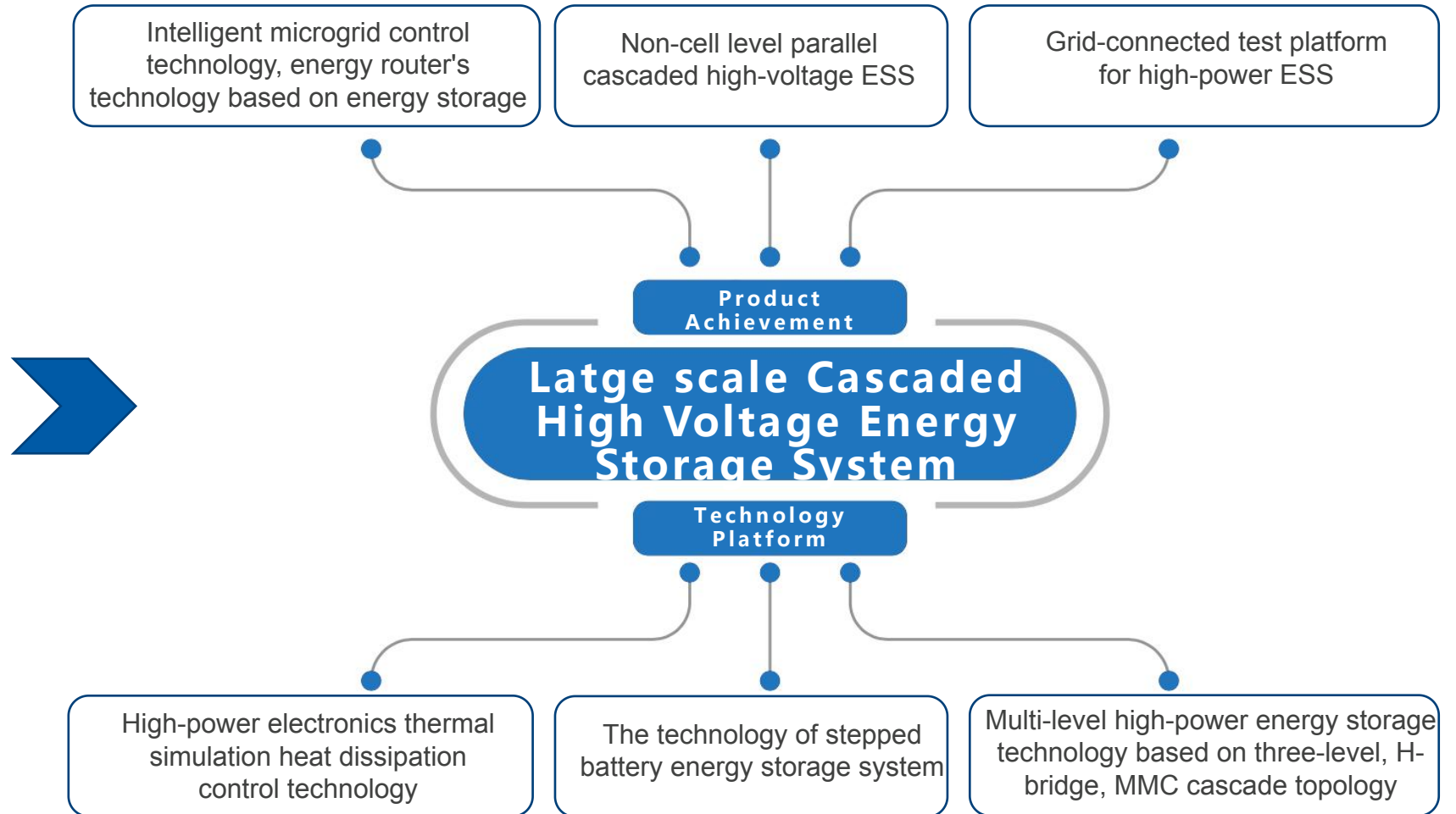

5、Core Team Member



Xinyu Jiang
Master Xi'an Jiaotong University
Director of National Enterprise
Technology Center Guangzhou
outstands expert, high-level
talents, The first batch of outstanding
industrial talents in Guangzhou.



Rui Zhang
Master of Engineering
Xi' an Jiaotong University
Years of experience in power
generation and renewable
energy management and
operation.



Weihong Wang
Master Department of Electrical
Machinery, Tsinghua University
Member of expert Bank of National
Energy Conservation Center
Focusing on power system control,
power electronics, and battery
management technology.



Dr. Liao Hui
Professor Electrical Engineering,
South China University of Technology
Guangzhou High-level Talents
Second prize winner of Technical
Invention of Ministry of Education.



Jin Jian Fu
Master More than 15 years of
high power electronic control
technology application research,
in charge of several large energy
storage projects system research.



Dr. Wang Mao
Electrical and Automation, Hefei
University of Technology
Focusing on power electronic control
technology and algorithm research.



Shengbing Wu
Master Electrical and Automation,
Hefei University of Technology
Focusing on power electronic
control technology and algorithm
research.



Ming Zhao,
Master Xi' an Jiaotong University
Focusing on power electronic control
technology and algorithm research,
engaged in power electronic control
for more than ten years.



Chen Lei
Bachelor Electronic Information and
Communication, East China Normal University
More than 10 years of lithium BMS
development experience, focusing on lithium
battery SOC/SOH management algorithm.

6、Qualification-Award



- 2018 the best system integration solution provider of Energy Storage in China.
- 2018 the best inverter supplier of Energy Storage in China.
- 2019 The best system integration solution provider in China's energy storage industry.
- 2019 The most influential enterprise in China's energy storage industry.
- 2019 Top 10 Energy Storage PCS Enterprises in China.
- 2019 The Third International Energy Storage Innovation Competition, "Energy Storage Technology Innovation Model TOP10".
- 2019 The winner of the 8th China Innovation and Entrepreneurship Competition (Guangzhou).
- 2020 Top 10 Energy storage PCS Enterprises in China.
- 2020 Top 10 Energy storage integrators in China.
- 2020 Energy Storage Cutting-Edge Enterprise Award.
- 2020 China energy storage industry most influential enterprise.
- **The first batch of science and technology innovation (energy storage) demonstration projects by the National Energy Administration.**
- **2019 CEC new product technology appraisal international leading evaluation.**

6、Qualification—Patents and Standards

60⁺

Technology patent accumulation

20⁺

Formulate national and industry standards



Before Guangzhou Zhiguang Energy Storage Technology Co., Ltd. was founded in 2018, has already applied for more than **60 patents**, and was responsible for drafting or participating in more than **20 national and industry standards** before the end of 2021.

6、Qualification-Certification



7、Industrialization Ability

- ◆ Standardized large-scale intelligent integrated production line, meeting the annual 7.5GWh Energy Storage System integration delivery capacity.
- ◆ Complete test ability, from battery cell to cluster on factory, high voltage power supply test conditions, up to 10MW energy storage system test ability.





02

Core Technology and Products



1、Introduction

-  Zhiguang has always continuous with the innovation of the energy storage industry, it is abandoned the existing energy storage technology to use batteries or battery cluster large-scale parallel combination to expand the capacity, discretize the unsafe parallel connection cluster, achieve single battery cluster level running, using the high-power electronic topology control technology which has already platformization, and combined to output power up to 25MW unit, and directly connects to 6-35kV voltage, which is more suitable for the construction of large capacity energy storage power on power generation and grid.
-  The core of this technology is using h-bridge cascade large-scale power electronic topology and control technology, which has been identified as the international leading technology by experts of CEC. It can up to 25MWh without any parallel connection on battery cell to cluster to improve the whole period security of the energy storage system, batteries running consistency and promote the efficiency of the system, and offers easy management, more secure energy storage system with lower cost to build a new power grid.
-  It has already been applied in The State Grid, China Southern Power Grid, Huaneng Group, Hudian Group, State Energy Group, Jingeng Group, Three Gorges Group, etc. with more than 400MW/450MWh project application and construction experience.

2、Core Technology

Exploring the Value of the Whole Life cycle of energy storage system

Unique cell use systemsolution
(No parallel connection on cell to cluster)

Comprehensive
monitoring and
protection

Intelligent warning
and online diagnosis

核心技术

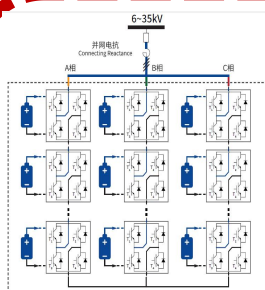

1

Cascaded high voltage PCS



2

Modular LV PCS

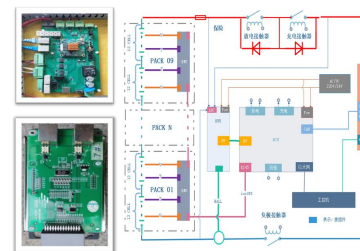

3

BMS2.0 based on dual-core ARM A9

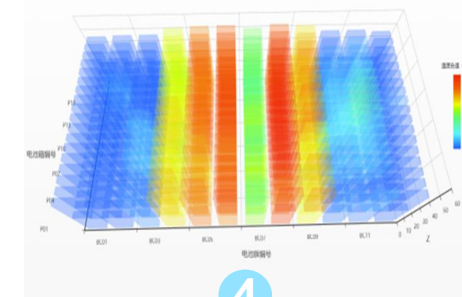

4

Energy Storage of Cloud collaborative big data
Analysis system

2、Product and Service

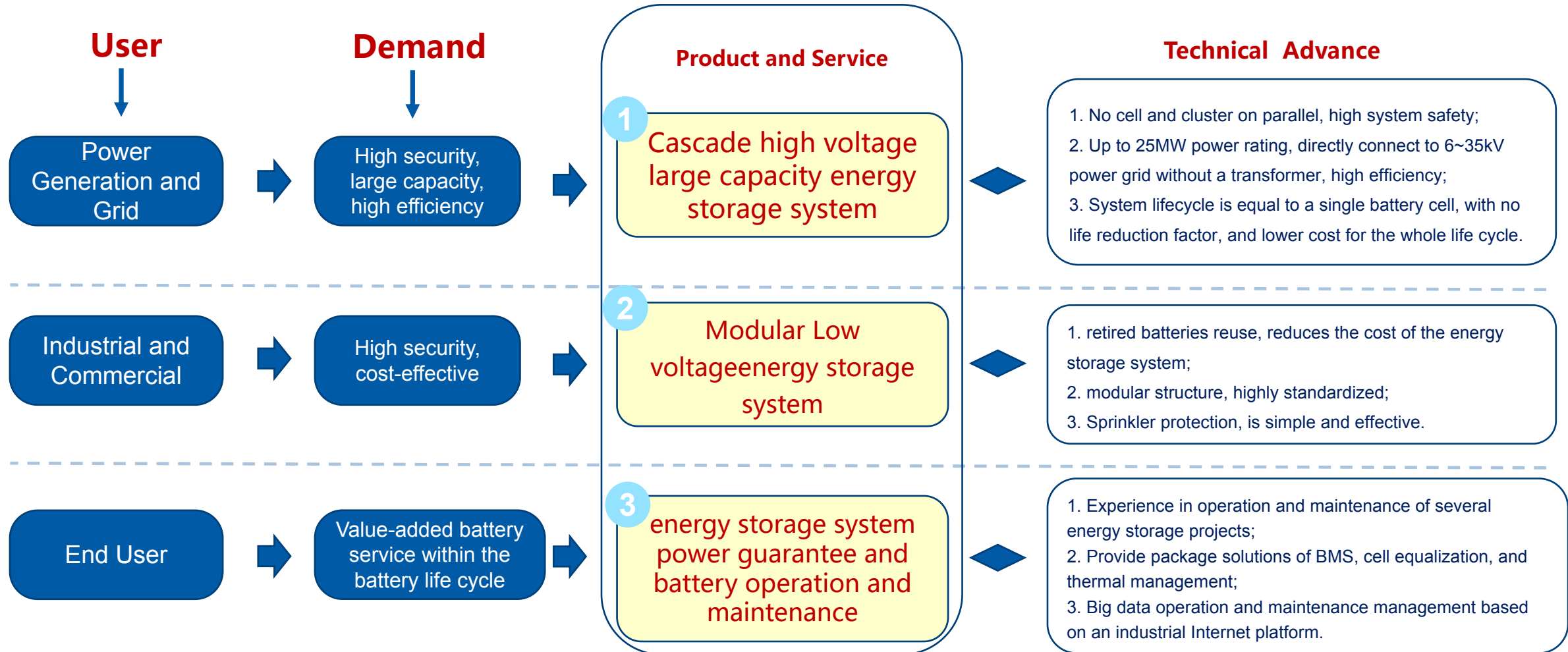

3、Core Product 1 —6~35kV Cascaded high voltage Energy Storage System

- The first batch of science and technology innovation (energy storage) .
- The first prototype creator with leading technology in the world, initiator and Pioneer of Cascaded High-voltage Large-capacity Energy Storage Technology, unique battery system application solutions.

The 6-35kV cascade high voltage energy storage system adopts the leading H-Bridge cascade power electronic topological structure in China. It can direct access to 6-35kV high voltage power grid without a transformer by several energy storage units and boost voltage through AC in series connect. which can reach 25MW power rating. It has repeatedly updated the single capacity record in the storage market. The efficiency of the whole energy storage system is 90~91%, which is the only technology in the world where the electrochemical energy storage cycle efficiency exceeds 90%. The product has the characteristics of no parallel connection on battery cell to cluster with the high power rating, high safety, high battery capacity utilization, and high efficiency, which can save more than 10% of the construction cost of a large energy storage power station.



Cascade High Voltage Energy Storage System

3、Core Product 1 —6~35kV Cascaded high voltage Energy Storage System

Technical Comparison (Base on 5MW/10MWh Energy Storage System)

Detail	Low Voltage Solution	Cascaded High Voltage Energy Storage System	Conclusion (级联优势)
Quantity	8×630kW	1×5MW	Large capacity, simple control
Output Voltage	0.4kV or less	10kV	Transformerless, high efficiency
Paralle Cluster	6	1	No Cluster Parallel Connection, high safety
Battery Capacity	1161kWh	193kWh	Less battery capacity management, high safety
Numbers of Battery	> 1300	224	No battery parallel connection
Battery Consistency	Due to the influence of operating temperature difference, resistance difference of battery cluster, and other factors, the consistency of cell operation is affected, part of the cell will be overcharged or discharged, and the degradation battery will accelerate.	No parallel connection on battery cluster. No influence on resistance difference of battery clusters, strong consistency. The cluster degradation slow	High battery consistency, battery cluster lifecycle is almost the same as a single battery cell, battery cell overcharge avoids
Cluster Utilization	< 80%	90%	Battery installation capacity reduce10% , investment cost saving
Step-Up Transformer	Yes	No	Transformerless, high efficiency
Point of Interconnection	2(2.5MW per Unit)	1	20% construction and grid connection costs saving
System Efficiency	~85%	≥90%	High efficiency
Response Time	100ms	<5ms	Fast response, strong grid support
Control	Difficult to coordinate multiple machines in parallel	Easy, direct control ESS	Easy to control, simplify equipments and improving reliability

3、Core Product 2 — Modular LV Energy Storage System

Due to the retirement battery having a unified voltage, and discretization parameter, under the standardization design and commercial customer requirement, a modular ESS system is necessary for development, which uses small rating PCS to achieve cluster level direct control. It can avoid parallel connection and solve cluster circulation current issues and minimize the potential risk, and achieve active equalization to balance the cluster energy balance.

This modular ESS (standard capacity: 250kW/500kWh) can expand by parallel connection on the AC side and can support DC 1000V and 1500V with 60kW, 125kW, and 180kW diversified power ratings.



Modular LV ESS System

3、Core Product 3 — Mobile Energy Storage Test Platform



移动式储能测试平台



6/10kV/6MVA 储能测试平台



35kV/4MVA新能源测试平台

The mobile energy storage test platform, with a four-quadrant converter as the core, has such functions as high and low voltage ride through, grid adaptability (frequency, voltage, and power quality adaptability (harmonics, internal harmonics, fluctuation and flicker, and three-phase unbalance)), and primary frequency modulation test ability. The mobile energy storage test platform adopts the H-bridge cascading topology, which has high amplitude and frequency accuracy of output voltage and low harmonic. The platform adopts a special rainproof structure design, which can operate all day without being affected by rain or snow. A voltage and current acquisition interface are reserved on the platform, which can integrate the test recording instrument and automatic test report analysis software for convenient testing. The platform takes 10kV/6kV as the core and can expand to 35kV, 600V, 400V, and other voltage levels according to customer requirements.

The company has provided large-scale high-voltage test power supply devices for China Southern Grid Technology Co., Ltd. and China Electricity Research Institute of State Grid, which are the two major power grid companies in China.

03

Typical Applications



1、 Cascaded High-Voltage Energy Storage System has Over Megawatts Application

- Zhiguang cascade high-voltage energy storage system has been applied to the State Grid, China Southern Power Grid, Huaneng Group, Huadian Group, CTGNE, China Energy Group, Guangdong Energy Group, and other customers, and the cumulative construction and commissioning projects by the end of 2021 exceed 400MW/450MWh. The project of Desheng Power Plant (Wusha Power Plant) in Shunde, Guangdong province was included in the first batch of scientific and technological innovation demonstration projects of the National Energy Administration.
- In 2022, the company successfully researched and developed 35kV cascading high-voltage energy storage, with 20MW/40MWh and the round trip efficiency is up to 91% which provides a more efficient, safe, and simple energy storage power station solution for large-scale shared energy storage power stations.
- Zhiguang has been leading the development of cascade high voltage and large capacity energy storage technology.

2、ESS Project in Shunde power plant——The first batch of science and technology innovation (energy storage) demonstration projects by the National Energy Administration



- 330MW Frequency modulation of coal power plant
- COD by 2019.11
- 9MW/4.5MWh
- AGC and Primary frequency modulation
- Maximum K-value up to 2.9
- GB/T36548-2018 test complete with excellent performance

2、ESS Project in Shunde power plant——The first batch of science and technology innovation (energy storage) demonstration projects by the National Energy Administration

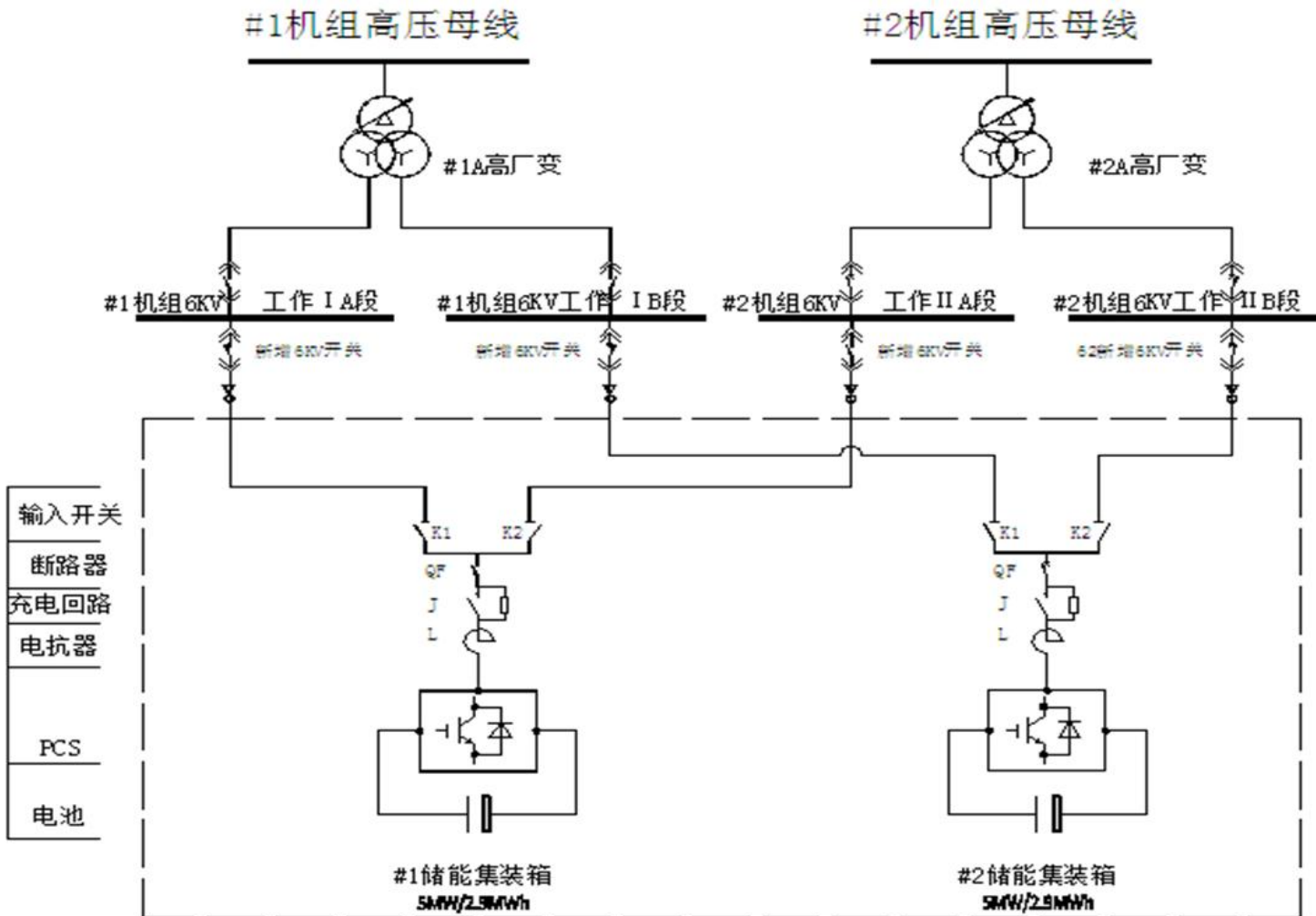

The total scale of the ESS for auxiliary frequency modulation in the coal power plant is 9MW/4.5MWh, consisting of six battery and power conversion containers and one central control container.

The energy storage system is connected to coal power plant unit 1 and unit 2 through the 6kV cable to the transformer Section A and B busbar. Through rapid and accurate charging and discharging, the secondary frequency modulation performance is greatly improved, and improve the frequency modulation income.

3、Maoming Coal Power Plant ESS project



- 600MW Frequency modulation of coal power plant
- 20MW/10MWh
- AGC and Primary frequency modulation
- 4 units of 5MW/ 2.5MWh energy storage systems in parallel operation, laying a solid foundation for building a larger scale energy storage power station

3、Maoming Coal Power Plant ESS project

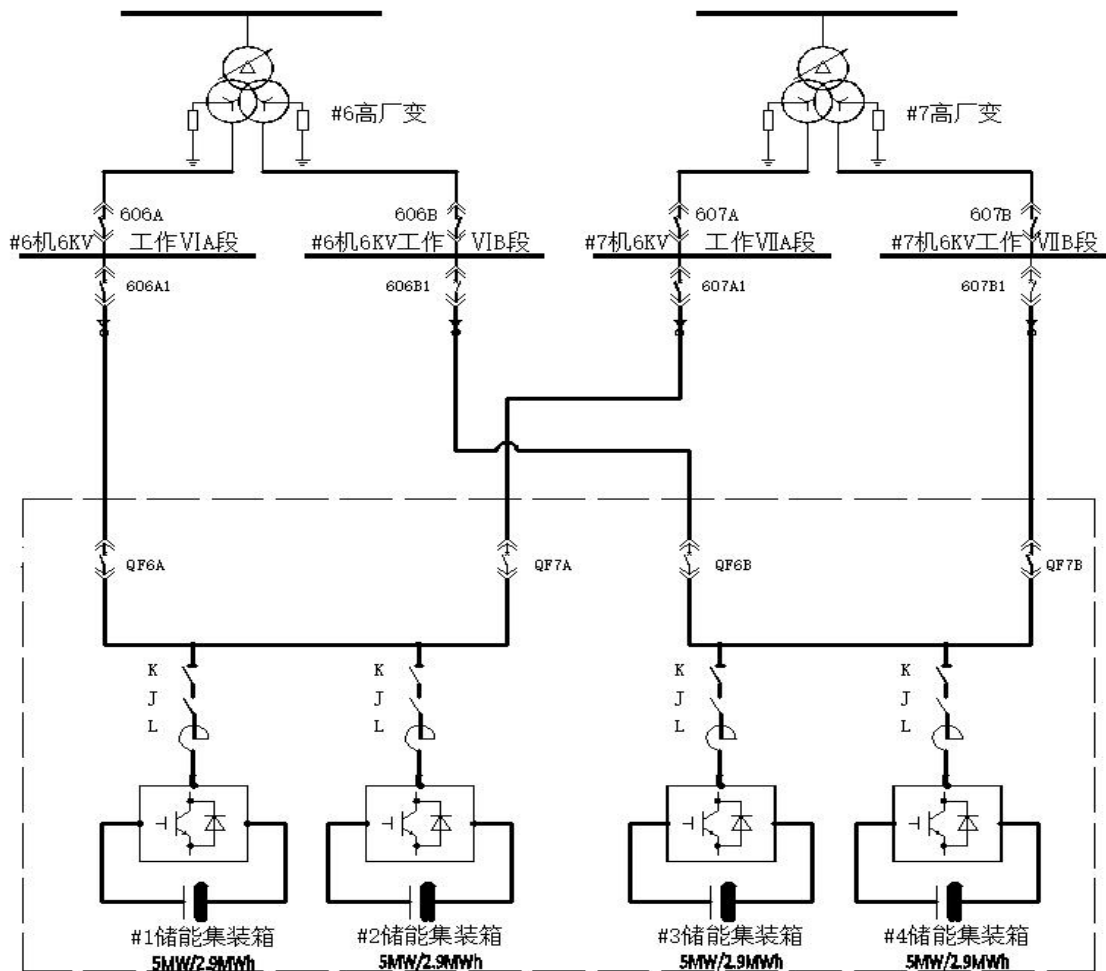

The total scale of the ESS for auxiliary frequency modulation in the coal power plant is 20MW/10MWh, consisting of 12 battery and power conversion containers, 2 central control containers and 1 master control container.

The storage system is connected to coal power plant unit 6 and unit 7 through the 6kV cable to the transformer. Through rapid and accurate charging and discharging, the secondary frequency modulation performance is greatly improved, and improve the frequency modulation income.

4、Huadian Group Coal Power Plant ESS Project



- 10MW/10MWh
- AGC, primary frequency modulation and peak shaving
- First time applying 1C energy storage system to the coal power plant

5、Huaneng Group Coal Power Plant ESS Project



- 9MW/4.5MWh
- AGC and primary frequency
- First time applying the cascaded energy storage system in the cold region of north China

6、Yuedian Group 1000MW Coal Power Plant ESS Project



- 30MW/15MWh, new record of the cascaded high voltage energy storage system
- AGC and primary frequency
- 1000MW Coal Power Plant frequency modulation

7、Guangzhou IDM chip factory power reliability ESS project



- 10MW/20MWh
- Grid side ESS, IDM chip enterprise power reliability and local power grid maintenance scheme optimization
- Consists of 1 primary equipment and 7 storage and PCS containers

7、Guangzhou IDM chip factory power reliability ESS project

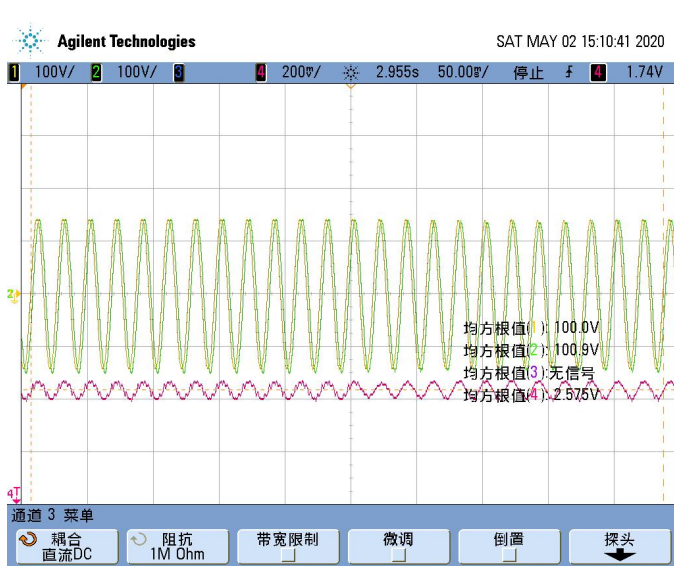

Waveform diagram of energy storage system when it is switched from off grid to grid with load

The green waveform line is the output voltage of the energy storage system, and the red and purple waveform lines are the load current

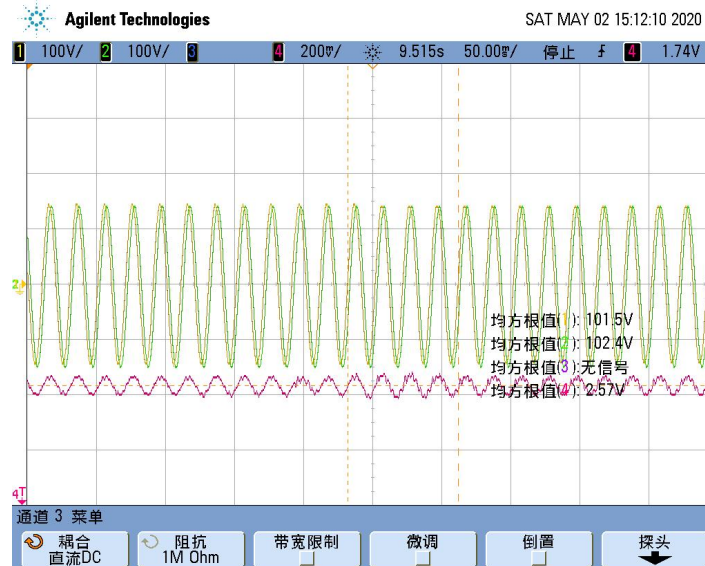

Waveform diagram of energy storage system when it is connected to and removed from the grid with load

The green waveform line is the output voltage of the energy storage system, and the red and purple waveform lines are the load current of the energy storage system

- Seamless switching without disturbance
- Black-start operation
- It can support peak-load shifting and demand side response to save electricity

8、Hunan Power grid Renewable Energy ESS Project



- 10MW/20MWh
- The first COD of hunan Power Grid Phase II renewable ESS project
- Consists of primary equipment and secondary equipment container, and 7 battery and PCS containers

8、Hunan Power grid Renewable Energy ESS Project

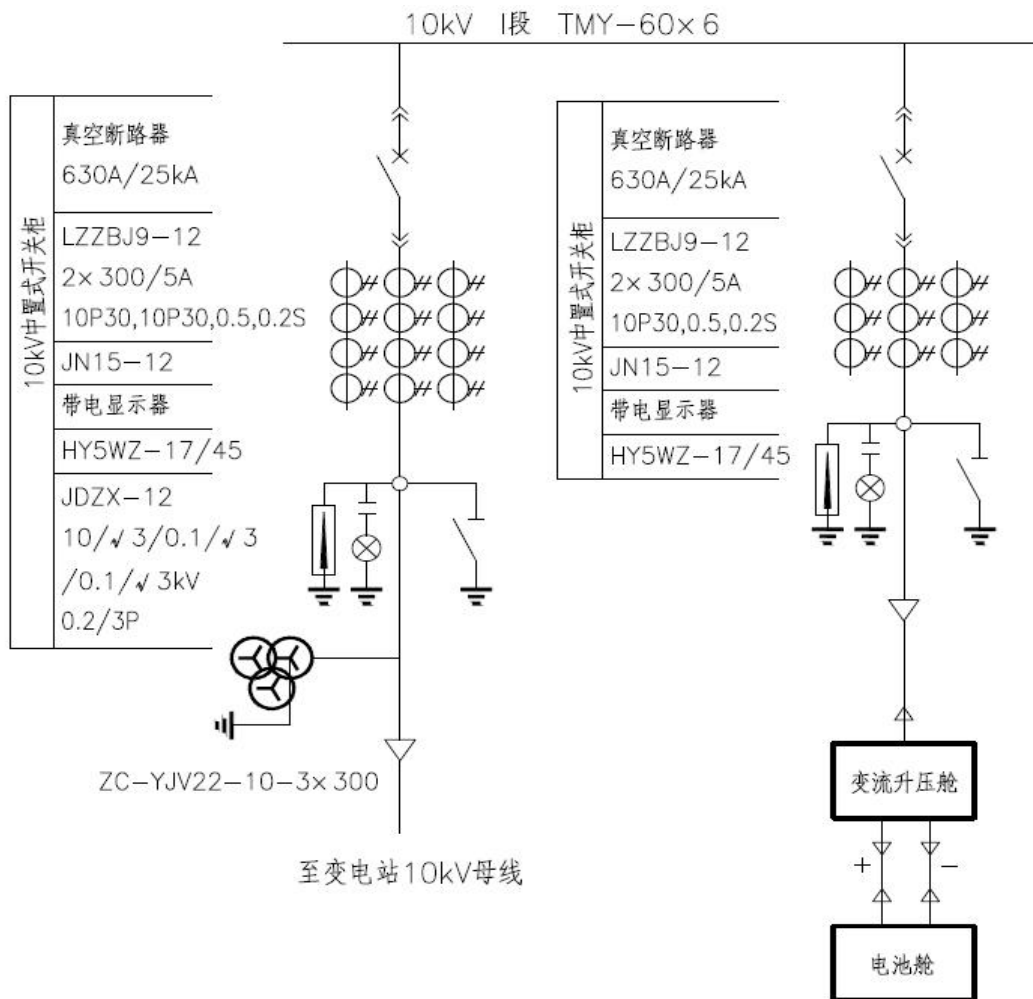

- Transformerless access to 10kV busbar of 110kV substation, reduce 10kV step-up transformer, simplify distribution system, save transformer loss more than 30%
- Variable frequency air conditioner control, more accurate temperature control, more auxiliary power consumption saving
- Equipped with perfluoro hexanone fire extinguishing agent and a variety of gas composite sensors

9、Guangdong Zhanjiang Power Supply Authority ESS Project



- 5MW/15MWh
- The first grid-side 3-hours ESS project of Guangdong Zhanjiang Power Supply Authority.
- Consists of 1 central control and 1 secondary container and 6 battery and PCS containers

Thank You

Initiator and Pioneer of Cascaded High-voltage Large-capacity Energy Storage Technology

Experts in Exploring the Whole Lifecycle Value of Energy Storage System